

Charles Universal Broadband Enclosure

CUBE-SS4C228BV1

General Description and Installation

1. GENERAL INTRODUCTION	1
1.1. Document Purpose	1
1.2. Product Purpose	1
1.3. Product Mounting and Location	1
2. PRODUCT DESCRIPTION.....	2
3. INSTALLATION	4
3.1. Inspecting the Product.....	4
3.2. Following and Using Safety Precautions.....	4
3.3. Obtaining Tools and Equipment.....	4
3.4. Preparing the Installation Site.....	4
3.5. Lifting the CUBE.....	5
3.6. Mounting the CUBE.....	5
3.8. CUBE Wiring and Equipment	7
3.9. Conduit Seals.....	11
3.10. Verifying the Installation.....	11
4. PERIODIC MAINTENANCE.....	11
5. TECHNICAL ASSISTANCE AND REPAIR SERVICE	11
6. WARRANTY & CUSTOMER SERVICE	11
7. SPECIFICATIONS.....	12
7.1. Regulatory Specifications	12
7.2. Product Specifications.....	12
7.3. Macro Alarm Panel Connections	13

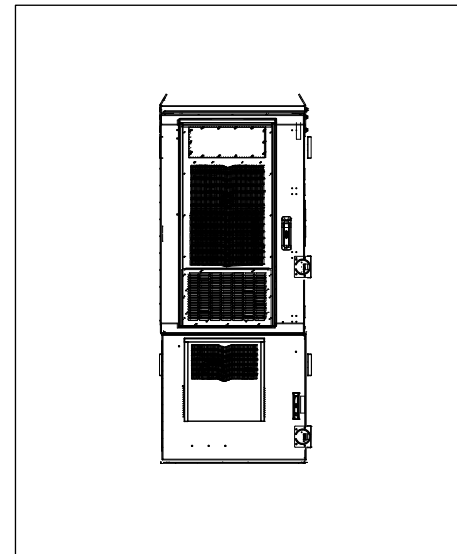

Figure 1 Front View of the CUBE

1. GENERAL INTRODUCTION

1.1. Document Purpose

This document provides general information for the CUBE-SS4C228BV1 of the Charles Industries' Universal Broadband Enclosure (CUBE) product line. Figure 1 shows a closed front view of the enclosure.

-NOTE-

Hereafter, the Charles Universal Broadband Enclosure CUBE-SS4C228BV1 will be referred to as the "CUBE."

1.2. Product Purpose

The CUBE consists of a protective enclosure for an integrated system of electronic components and equipment that can serve fiber and copper interfaces.

1.3. Product Mounting and Location

This enclosure is suitable for outside plant-type (OSP) locations and those that may require NEC compliance. The outdoor, weather-resistant CUBE is to be mounted on a concrete pad or steel grate platform. The installer connects the power, fiber, and copper connections. Detailed mounting and installation information is covered in Section 3.

2. PRODUCT DESCRIPTION

The CUBE consists of two compartments. The equipment compartment includes 8RU of 23" horizontal rack mounting space, 20RU of 19" horizontal rack mounting space, and 7RU of 19" vertical rack mounting space. It also has a 14kBTU HVAC system. The battery compartment supports three strings of customer supplied VRLA batteries and includes 1.7kBTU HVAC system. The CUBE can be connected to the CUBE-BB48E2QVA battery backup cabinet for added battery power.

Figure 2 shows the CUBE dimensions. Figure 3 shows the main components of the CUBE.

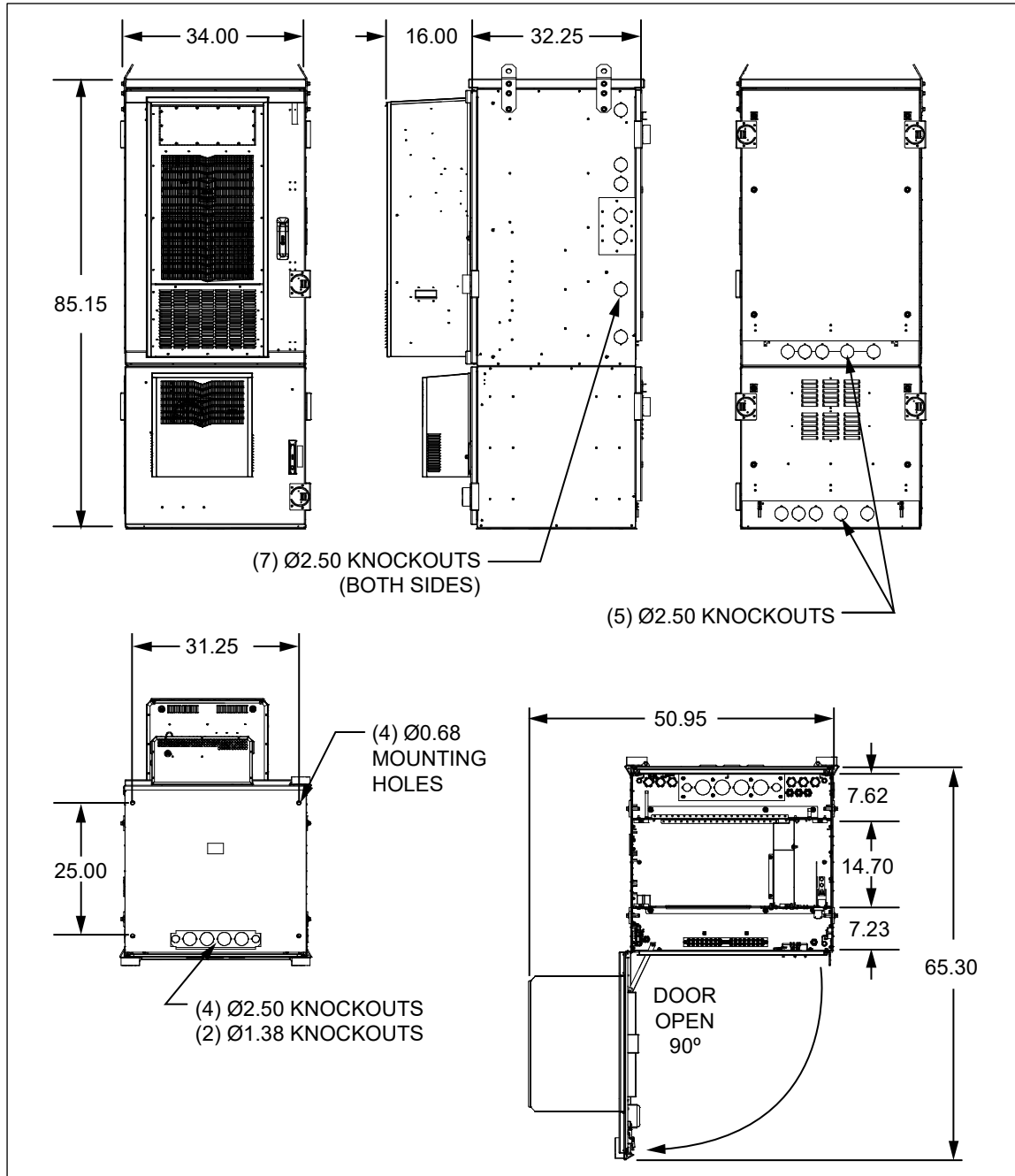

Figure 2 CUBE Dimensions (in inches)

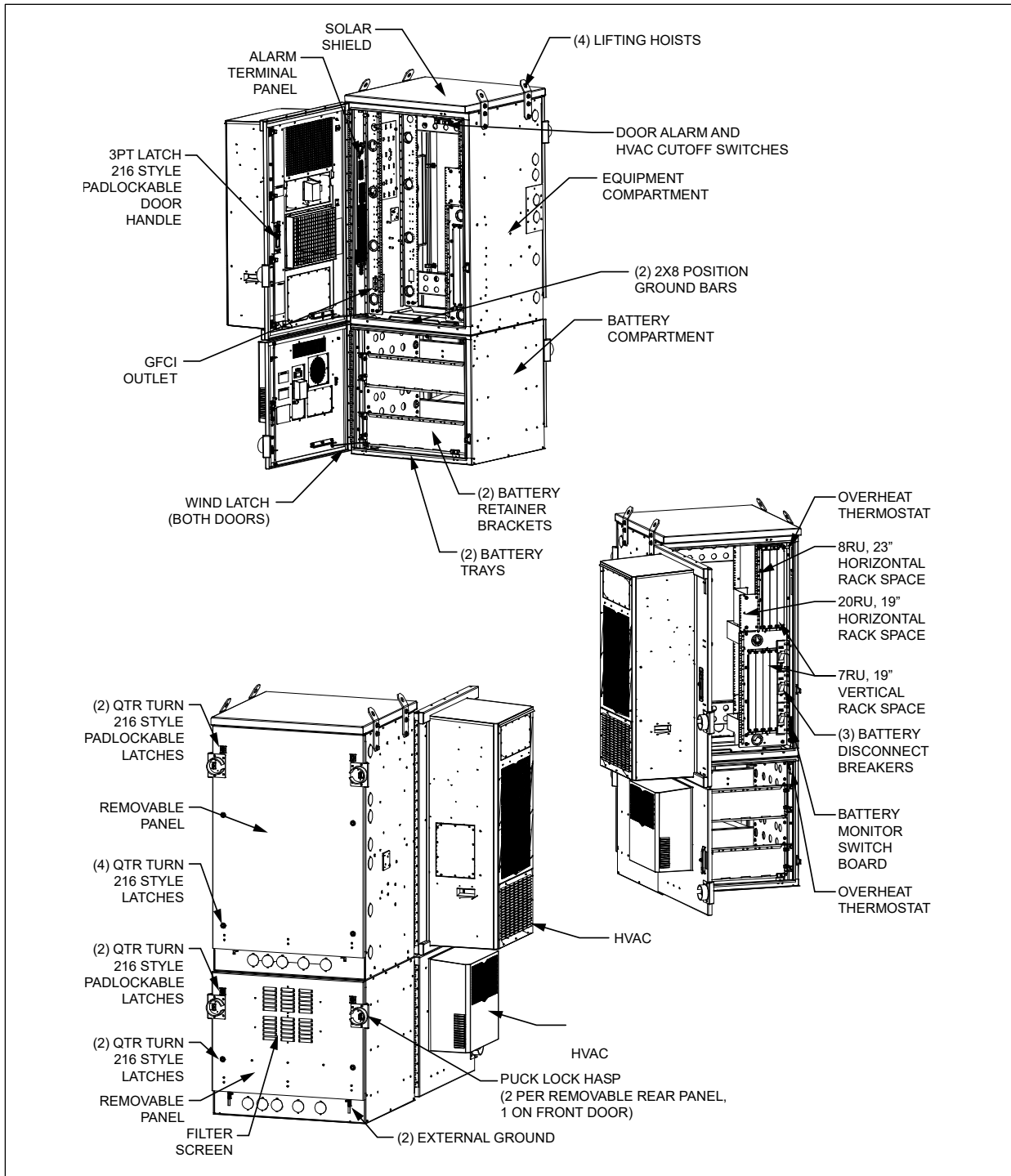

Figure 3 CUBE Components

3. INSTALLATION

3.1. Inspecting the Product

The CUBE is shipped mounted upright on a skid. Remove the bolts, unpack the unit, and dispose of the packaging material.

-INSPECTION NOTE-

Visually inspect the unit for damages prior to installation. If the equipment was damaged in transit, immediately report the extent of the damage to the transportation company.

3.2. Following and Using Safety Precautions

Read the following site and safety tips, cautions, and warnings, then proceed with the paragraphs that follow.

- For installation, follow all National Electrical Codes (NEC) ANSI/NFPA 70, local, environmental, workplace, and company codes, safety procedures, and practices.
- Minimum spacing between the accessories and components and the housing for ITE equipment shall be maintained for safe operation of the equipment when installed in accordance with NEC ANSI/NFPA 70.
- Read all instructions, warnings and cautions on the equipment and in the documentation shipped with the product.
- Always connect ground connections first.
- Do not place this product on weak or unstable surfaces which may allow the product to fall, resulting in potentially serious damage(s) to persons or product.
- Only authorized trained personnel shall install the CUBE.
- In windy conditions, be sure to engage the door latches to secure the door in a stationary position.

3.3. Obtaining Tools and Equipment

Obtain the following recommended or needed items for installing the CUBE.

- Sufficient length and quantities of fiber cable (or pigtails)
- Cable scoring, opening, and cutting tools for cable sheathing, shields, wrappings, strength members and buffer tubes
- Wire strippers
- Crimpers
- Cable, tube, wire, and fiber cleaning materials
- Protective and/or insulated work gloves
- Safety glasses
- Tape measure
- Marking utensil
- #6 ground wire or rod and earth ground materials
- Bond strap (optional, from cable bond clamp to bond post)
- Any exterior cable strain relief, per company practice
- Slotted, hex, and Phillips screwdrivers
- Torque wrench
- Assorted cable ties, clips, or fasteners (optional)
- Can wrench (216 type tool)
- Derrick for lifting
- Level

3.4. Preparing the Installation Site

Observe the following site preparation recommendations.

- Leave adequate horizontal and vertical space between multiple installations to allow for proper cable access, as well as enough room around the enclosure to open the door(s).
- The site must meet minimal personnel and equipment safety requirements.
- The distance from the cable entry point should be consistent with local installation practices.
- The pad or platform must be able to support the weight of the CUBE.
- Run all fiber and copper facilities to the site.

3.5. Lifting the CUBE

See Table 1 for CUBE weight. Charles recommends the following procedure for lifting the CUBE.

3.5.1. Required Equipment

- One derrick (crane) capable of lifting the CUBE
- Four lifting slings or chains with each having a 2,500 lbs. capacity
- Connecting links to attach slings to the CUBE's lifting brackets
- 75-ft. long tagline rope

Insert the lifting sling connecting links securely through each of the lifting brackets as shown in Figure 4.

3.5.2. Warnings and Specific Safety Precautions

	WARNING	<p>Improper hoisting equipment and unsafe lifting procedures can result in serious injury or death</p> <p>Because of the added risk of injury or damage, do not lift enclosures with batteries installed.</p>
---	----------------	---

Observe the following local safety procedures when performing the tasks in this section.

- Keep the CUBE away from any power lines.
- Keep bystanders away from the work operations at all times.
- Only trained operators shall operate the crane for lifting and setting the CUBE.
- Do not suspend loads over people or equipment.
- All persons working with hoisting equipment shall wear standard safety gear according to local practices including safety helmets and steel-toed shoes.
- Do not operate the hoisting equipment until all stabilizers are extended and in firm contact with the ground or adequate support structure.
- Do not attempt to retract or extend the stabilizers while a load is suspended.

3.6. Mounting the CUBE

The CUBE can be mounted on a new or existing concrete pad. A gasket is affixed to the bottom of the CUBE for placing the CUBE on a concrete pad. If the gasket becomes damaged during installation, order a replacement under part number 80-006667-A. Ensure that the unit is level.

3.6.1. Torque Requirements

Torque all hardware as shown below (unless otherwise noted). These values apply to SAE Grade 1 & 2 Low Carbon Steel, ASTM A307 Low Carbon Steel, and Stainless Steel Grade 18-8.

Thread Size	In-lbs	Ft-lbs
4-40	4±10%	
6-32	8±10%	
8-32	16±10%	
10-32	26±10%	
12-24	50±10%	
1/4-20/M6	60±5%	5±5%
5/16-18	125±5%	10.4±5%
3/8-16	180±5%	15.0±5%
1/2-13	500±2%	41.7±2%
5/8-11	1000±1%	83.3±1%

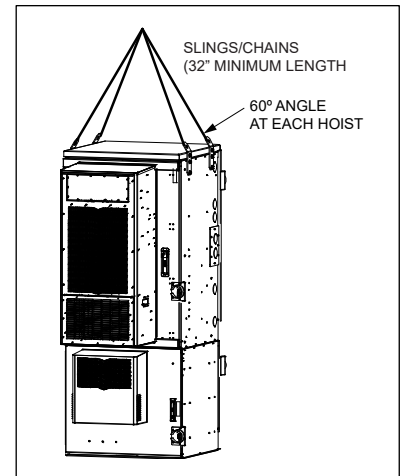

Figure 4 Lifting the CUBE

3.6.2. Constructing a New Pad

- Use only concrete for new pad construction. Do not use substitute materials since they lack the rigidity for CUBE placement.
- Observe local building practices for pad construction. Charles recommends that the pad should extend a minimum of 8” beyond the CUBE base on all sides.
- Use a minimum of 6” of sand or gravel as a base for the pad for leveling purposes.
- Figure 5 shows the required conduit openings and mounting hole dimensions for entering/mounting the bottom of the CUBE. Use these dimensions when designing the pad.

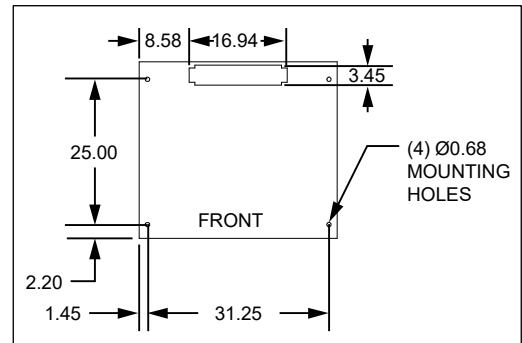

Figure 5
Mounting Hole Dimensions (in inches), Top View

	WARNING	<p>When pad mounting, the compression strength of the pad must be at least 4000 psi as determined by ASTM C39 test of compression strength of concrete cylinders.</p> <p>The slump of the concrete shall be 2” to 4” as determined by ASTM C143 test method.</p>
--	----------------	--

3.6.3. Mounting the CUBE on a Pad

Four customer supplied, corrosion resistant, 1/2”-13 hex head bolts with anchors are required for mounting the CUBE to the concrete pad. Use the following steps to mount the CUBE to a pad.

1. Layout, drill, and set the 1/2” anchors per manufacturer’s recommendations. The embedment depth is not to exceed 3.5”.
2. Clean any debris from the concrete pad.
3. Open the battery compartment to allow access to mounting holes.
4. Ensure that the CUBE is parallel to the pad surface as it is placed onto the pad and that it aligns with the holes in the pad and the gasket. Dress the cable/conduit so that it aligns with the CUBE openings as it is lowered onto the pad.
5. Place the CUBE on the pad. Loosen the slings so that all the weight is on the pad. Check that the CUBE is properly aligned.
6. Secure the CUBE to the pad using the 1/2”-13 hex head bolts. Tighten all bolts securely.
7. To secure the CUBE to a steel grate platform, install 1/2” corrosion-resistant Grade 5 steel hardware through the cabinet and platform grate. Ensure that the bolts are long enough to extend past the nut on the bottom side of the platform grate. For all mounting applications, each bolted joint should have a minimum Ø1 inch fender washer on the inside of the cabinet (and underside of the platform grate for platform mounting) with a lock washer. The washer on the underside of the platform must be large enough to cover both adjacent bearing bars as shown in Figure 6.
8. Once the CUBE is secured, remove the slings and tagline. Close the door.

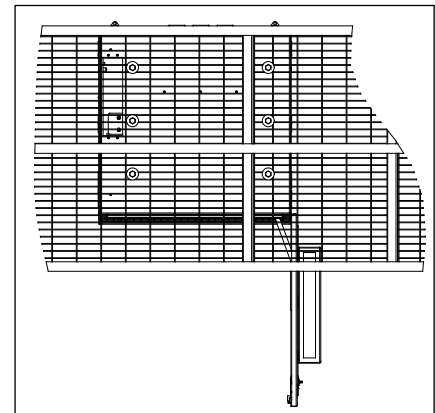

Figure 6 Installing on a Platform

3.8. CUBE Wiring and Equipment

After the CUBE is properly mounted in the desired location, apply No-Ox where bus bar and other 2-hole lug connections will be made. Install ground and power connections. Always ground the equipment first, before making any other connections.

WARNING Perform all bonding and grounding connections prior to any electrical and communications connections.

In order to prevent condensation prior to being placed in service, do not remove the desiccant until the CUBE is sealed and power is applied. A basic electrical diagram is shown in Figure 7.

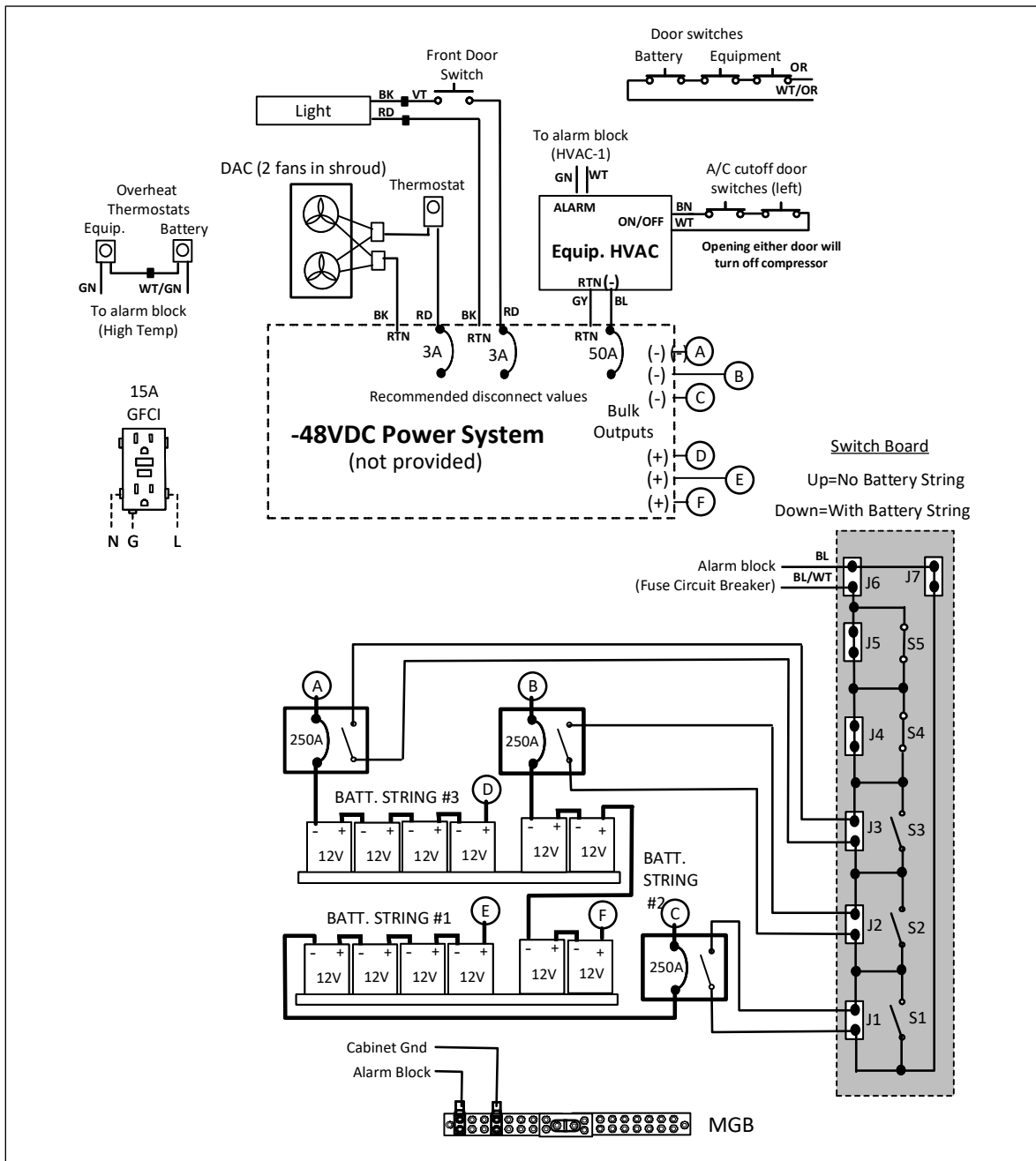

Figure 7 Electrical Diagram

3.8.1. Ground Connection

Use the two 2x8 position ground bars provided in the equipment compartment for all grounding of internal equipment. Stack hardware as shown in Figure 8. External ground lugs are available on the rear of the battery compartment for connecting a site ground wire.

3.8.2. Battery Connection

	WARNING	<p>Always turn off battery breakers prior to servicing batteries.</p> <p>If using VRLA batteries, ensure that the power system is set up for VRLA batteries with temperature compensation enabled.</p>
--	----------------	--

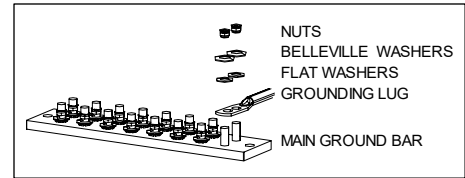

**Figure 8
Ground Bar Hardware Stack**

Verify the polarity of the cables prior to terminating them to the batteries. Ensure the battery terminations are properly insulated to avoid shorting prior to terminating to the batteries.

1. Switch off the battery breaker located in the equipment compartment.
2. Remove the battery retainer bracket by removing the hardware.
3. If replacing batteries, disconnect battery cables from terminals and loosen the battery retaining strap(s).
4. Remove the battery temperature probe.
5. Remove the interconnecting straps from the batteries. Remove batteries.
6. Carefully position the new batteries on the battery tray. Connect the interconnecting straps to each battery string.
7. Replace battery temperature probe to the closest battery.
8. Connect the battery cables to the appropriate terminals.
9. Secure the battery retaining straps and reinstall the battery retainer brackets using hardware from step 2.
10. Properly manage the battery cables.
 - o Ensure that the bending radius does not exceed than 5x the cable diameter (e.g. 4/0 battery cable = 4 inch bend radius).
 - o Use as few bends as possible between the two termination points.
 - o Do not bend the cable at the termination points.
11. Switch on the battery breaker.

Notes:

- Battery breakers terminate at the power shelf.
- Ensure temperature compensation probes are installed per power system guidelines.
- Ensure back up battery amperage is inputted into the power system controller per power system guidelines.
- Ensure float voltage is set per power system and battery guidelines.
- Ensure all battery terminations and bus bars have No Ox applied.
- Refer to the battery manufacturer’s documentation for proper battery installation and maintenance information.

3.8.3. Battery Breaker Monitor Switch Board

The CUBE has a switch board on the right inside panel that is connected to the battery breakers and serves as an alarm monitor. The default switch setting is to the bottom, indicating that a battery string is present, and the battery breaker is turned on. If any battery breaker is turned off or tripped, it will cause a normally open alarm connection on the alarm block “BAT BRKR” position. If no battery string is present, then move the switch for that shelf into the top position to bypass the breaker.

3.8.4. HVAC Operation

Equipment Compartment:

The DC powered 14kBTU HVAC and 500W/K DAC hybrid unit operates mainly in HVAC mode and switches automatically to emergency filtered direct air cooling (EM/DAC) mode when specific unit alarm conditions (temperature and humidity) are met. The emergency DAC mode remains active until all alarms clear.

The HVAC/DAC temperature regulation follows “precision control” logic with a PID (proportional integral derivative) controller for the fans/compressor speeds to maintain the respective temperature set points. The maximum internal airflow to the equipment is 883CFM.

The EM/DAC system includes an F9/MERV16 high-performance filter for cleaner operation. A built-in damper controls the flow of outside air and switches automatically between the closed and open positions during operation of the HVAC and DAC modes. The unit contains a humidity sensor to ensure the DAC mode does not function when the outside humidity is above 85% to prevent condensation inside the cabinet. A pressure switch is included to inform the customer of the need to change/clean the filter before clogging.

The HVAC mode starts running at 35°C at various speeds, remaining on until the internal temperature is below 30°C. During an HVAC compressor alarm or if the unit goes into LVD mode due to commercial power loss, the unit enters EM/DAC mode at low speed when the internal temperature reaches 50°C. It remains on until the temperature drops below 32°C or when the alarms clear. The fans adjust speed accordingly to maintain the set point temperature. The heating cycle turns on at 10°C and off at 15°C. The evaporator fan runs continuously at 70% speed during this cycle.

The CUBE is equipped with a cutoff switch that shuts off the HVAC compressor when a door is opened to minimize condensation buildup on the coils. For further information, refer to the HVAC documentation that ships with the CUBE.

System	On	Off	Notes
Active Cooling (HVAC)	35°C	30°C	Speed-regulated compressor & fans. The compressor varies speed between 2000rpm & 3200rpm.
Emergency Cooling (EM/DAC)	50°C	32°C	Speed-regulated evaporator & condenser fans
Idle Mode (Compressor is off)	30°C	10°C	Evaporator fan @ 30% speed / Condenser fan is off
Heating Mode	10°C	15°C	Evaporator fan @ 70% speed / Condenser fan is off
High Temp Alarm Setting	65°C	63°C	
Low Temp Alarm Setting	0°C	2°C	
Internal (evaporator) Fan Setting	-40°C	-	The fan runs continuously at 30% speed when the compressor is off. It will vary speed between 50% & 100% when the compressor is on.
External (condenser) Fan Setting	35°C	30°C	The fan is off when the compressor is off. It will vary speed between 30% & 85% when the compressor is on.

Battery Compartment:

The 1700BTU DC powered HVAC compressor and fans are PID (proportional integral derivative) controlled. The compressor turns on at 25°C at low speed and will increase speed as needed to maintain that temperature. The compressor turns off at 22°C. The internal fan is always on at low speed to continually circulate heat within the cabinet. The heating cycle turns on at 8°C and off at 13°C. The CUBE is equipped with a cutoff switch that shuts off the HVAC compressor when a door is opened to minimize condensation buildup on the coils. For further information, refer to the HVAC documentation that ships with the CUBE.

-NOTE-

Changing the cooling or heating cycles' default factory set points can lead to system performance issues, such as equipment failures, increased power use, unnecessary alarms, noise, condensation build up, compressor or fan failure caused by excessive runtimes and vibration.

Avoid placing items in front of the HVAC's return and supply vents. Maintain a minimum of 6" clearance to enable proper air flow.

3.8.5. Cooling Zone

The CUBE has an optimum cooling zone located at RU8 to RU15 that aligns with the HVAC system's supply vent (Figure 9). All critical customer equipment (e.g. server equipment or CSR) should be installed in this zone for thermal protection.

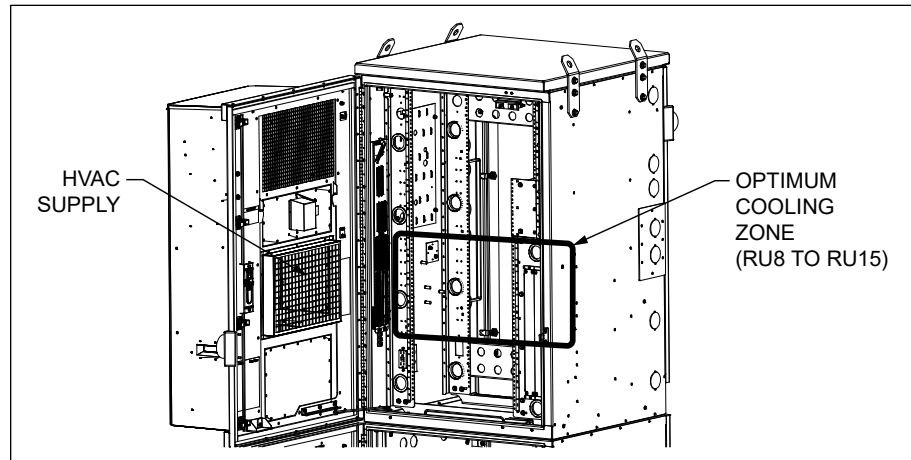

Figure 9
Optimum Cooling Zone

3.8.6. Overheat Thermostat

The CUBE is equipped with overheat (high temperature) alarm thermostats in the equipment and in the battery compartments. These overheat thermostats are wired in series and provide a normally closed connection. The equipment compartment overheat alarm is set for 50°C and the battery compartment overheat alarm is set for 35°C. Either alarm opens the connection if its temperature set point is exceeded.

-NOTE-

Changing the overheat (high-temp) thermostat default factory set points can lead to unnecessary alarms or system performance issues, such as equipment failures as a result of unreported alarms.

3.8.7. Macro Alarm Terminal Panel

An integrated macro-site alarm panel is mounted on the left wall of the cabinet. This panel provides forty protected dry contact alarm inputs to screw down terminals or 66-block connections (Figure 9). The cabinet comes with a standard alarm schedule label (See Table 2). The table can be replaced or augmented to match the specific alarms being used. All connections are normally closed and open on alarm.

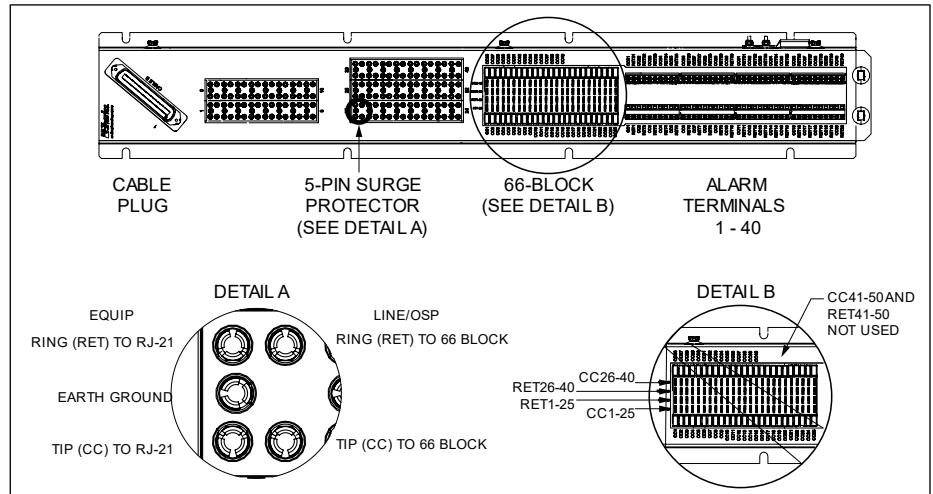

Figure 9 Alarm Terminal Panel

3.8.8. Fiber and Copper Entry

The CUBE has multiple Ø2.50" knockouts on the sides, rear, and bottom that support Ø2.00" conduit fittings. The bottom also has two Ø1.38 knockouts that accommodate Ø1.00" fittings. See Figure 2 for knockout locations.

3.9. Conduit Seals

All internal and external conduit openings on the CUBE must be completely sealed with a duct seal compound to prevent moisture from entering the equipment compartment. The battery compartment must be internally sealed from the equipment compartment to prevent outgassing from the batteries into the equipment compartment. Use a moldable, flame-retardant putty style duct seal material. Do not use an expanding foam seal. Mold the putty so that the open space around the wire or conduit is completely sealed, as shown in Figure 10. If the openings must be accessed at any time, remove the putty and set it aside. When work is complete, re-mold the putty to re-seal the opening.

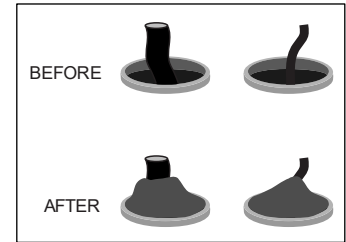

Figure 10 Applying Putty Seal

3.10. Verifying the Installation

Verify that earth ground and all grounding and bonding is complete and functional. After verifying that all installer connections are secure and complete, apply voltage.

4. PERIODIC MAINTENANCE

In the event that the enclosure must be opened in freezing conditions, use a narrow, pointed metallic object such as a screwdriver or chisel, along with a non-metallic device like a rubber mallet, to remove excessive ice buildup around the door and locking mechanism. A commercial aerosol de-icer spray can be used to free up locks and latches if needed. Use protective gloves and safety glasses when applying de-icer sprays.

Periodic cleaning of the filter screens is important to maintain proper ventilation. To clean the filter screens, remove the four nuts on each screen and take out the screens. Use a soft brush or hose to remove any debris from the screen. Once clean, replace the screens using the four nuts removed previously.

Reset the GFCI duplex receptacle periodically to ensure it is working. The unit meets UL-943, which requires an auto-monitoring (self-testing) feature. A flashing or solid red LED indicates a fault. If the unit continues to show a fault after resetting, replace the unit.

Refer to the HVAC manual supplied with the HVAC for periodic maintenance requirements.

5. TECHNICAL ASSISTANCE AND REPAIR SERVICE

For questions on product repair or if technical assistance is required, contact Charles Technical Support. It is best practice to contact Tech Services while on site with the cabinet.

847-806-8500

techserv@charlesindustries.com (email)

<http://www.charlesindustries.com/techserv.htm>

6. WARRANTY & CUSTOMER SERVICE

Charles Industries LLC offers a one-year warranty on the CUBE product. The Charles warranty is limited to the operation of the CUBE hardware as described in this documentation and does not cover equipment that may be integrated by a third party. The terms and conditions applicable to any specific sale of product shall be defined in the resulting sales contract. For questions on warranty or other customer service assistance, contact your Charles Customer Service Representative.

847-806-6300

mktserv@charlesindustries.com (email)

http://www.charlesindustries.com/main/telecom_sales_support.htm

7. SPECIFICATIONS

7.1. Regulatory Specifications

- Designed to meet GR-487
- GFCI: UL-943 Listed

If CUBEs are field-modified, a customer provided ETL field evaluation of the modified components may be required to re-establish ETL certification to UL standards. Consult local jurisdictions for guidance on a site-by-site basis.

7.2. Product Specifications

Physical	
Dimensions	85"Hx34"Wx32"D
Weight	Approx. 860 lbs. as shipped
23" Equipment Rack Space and Hole Spacing	14" (8RU) rack spacing with tapped EIA #12-24 mounting holes
19" Equipment Rack Space and Hole Spacing	47.25" (27RU) rack spacing with tapped EIA #12-24 mounting holes
Battery Tray Size	10.8"Hx25.6"Wx32.6"D
Maximum Supported Weight	Rack Rails: 374 lbs. Battery Tray: 500 lbs. per battery tray
Materials	0.125" aluminum
Color	Off-white
Electrical	
Supported Batteries	VRLA, 12V
Bonding and Grounding	(2) 2x8 position ground bars in equipment compartment, 2 external grounds
Cable Entry	See Figure 2. Section 3.8.8
Thermal	
HVAC System – Equipment Compartment	48VDC, Vikinor VAF-4000L
Cooling Capacity – Equipment Compartment	14000BTU
HVAC System – Battery Compartment	48VDC, Vikinor VAK-500
Cooling Capacity – Battery Compartment	1700BTU
Environmental	
Operating Temp. Range, Outside Enclosure	-40° to +115°F, -40° to 46°C
Operating Temp Range, Inside Enclosure	-40° to +149°F, -40° to 65°C
Humidity	0 to 95% (non-condensing)
Altitude	Up to 2,000 meters (6560 feet)
Kits and Replacement Parts	
Touch-up Paint	02-000290-0
216 Type Security Tool	07-002070-0
Replacement Gasket	80-006177-A
Shim Kit for Leveling	97-000010-0
Lift-Up Handle	39-000335-0
Door Rod Latch	39-000336-0
1/4 Turn Latch	39-000142-0
1/4 Turn Latch with Padlock Hasp	39-000311-0
4-Wire Door Alarm Switch	17-400329-0
HVAC Cutoff Switch	17-400322-0
GFCI Outlet	15A 04-100207-0
Overheat Thermostat	99-004548-0
Battery Disconnect	18-908176-0
Battery Backup Cabinet	CUBE-BB48E2QVA
HVAC Filter	39-000260-0 (for both HVACs)

Table 1 CUBE Specifications

7.3. Macro Alarm Panel Connections

Alarm Number	Description
CC1	Door Intrusion
CC2	Commercial Power Failure
CC3	Surge Suppressor/Lightening Arrestor
CC4	Rectifier Failure
CC5	Multiple Rectifier Failure
CC6	Battery Discharge
CC7	Low Voltage
CC8	DC Power Failure
CC9	Generator Running
CC10	Generator Low Fuel
CC11	Generator Failure
CC12	HVAC Failure
CC13	High Temp
CC14	Low Temp
CC15	Tower Light
CC16	Tower Light Side
CC17	RRH Up-Convertor Failure
CC18	RRH Power Failure
CC19	RRH High Humidity
CC20	RRH Intrusion
CC21	Smoke/Fire
CC22	Bus Bar Theft
CC23	Battery Breaker Alarm
CC24	
CC25	Microwave Critical
CC26	Microwave Major
CC27	Dehydrator Alarm
CC28	Fire Suppression Discharge
CC29	Fire Suppression Trouble
CC30	Secondary HVAC Running
CC31	Explosive Gas
CC32	High Humidity

Table 2 Macro Alarm Wiring Table