

CABLE ENTRY:  
 4" BOOT - (8) ON LEFT  
 BLANK PANELS - (1) ON LEFT, (3) ON RIGHT  
 (2) ON REAR  
 (1) GPS ENTRY ON LHS, (1) GPS ENTRY ON RHS

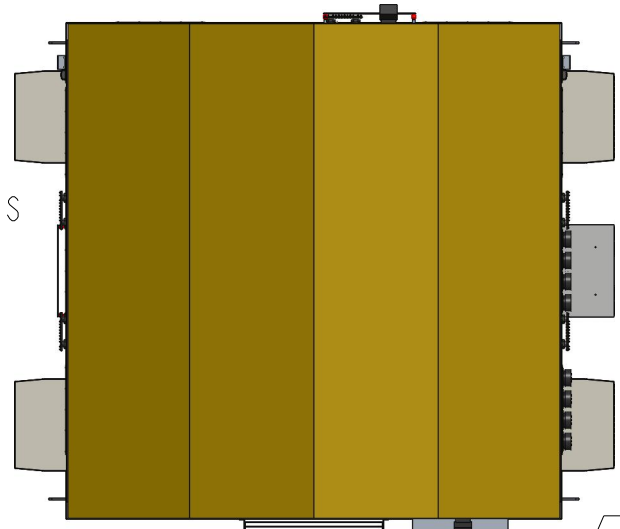

WIC TOP VIEW

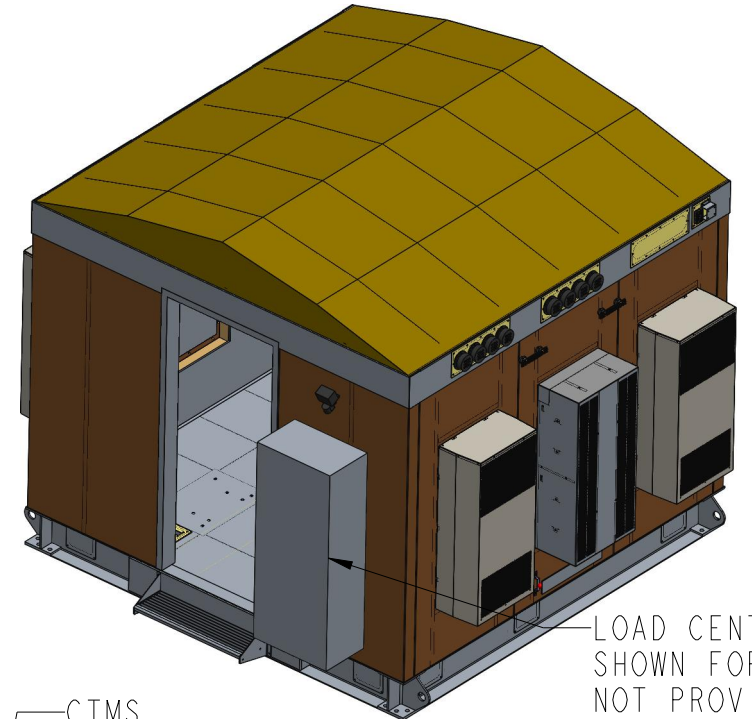

LOAD CENTER  
 SHOWN FOR REFERENCE  
 NOT PROVIDED BY CHARLES

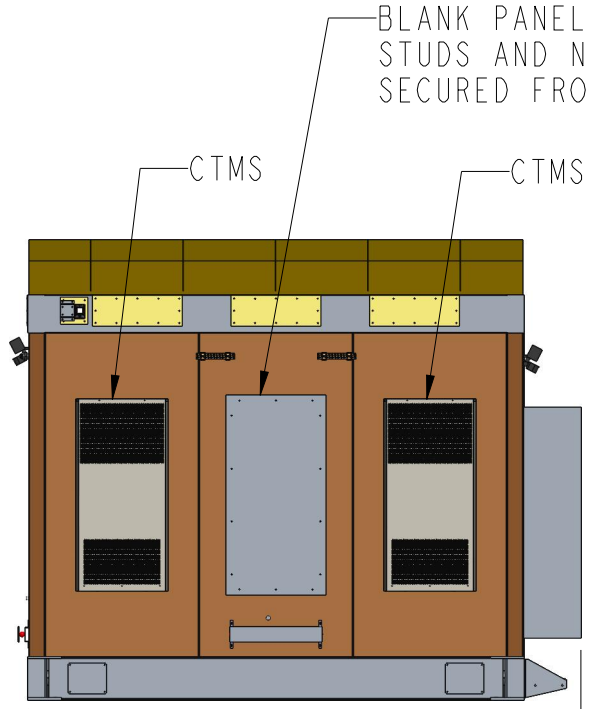

WIC LEFT SIDE VIEW

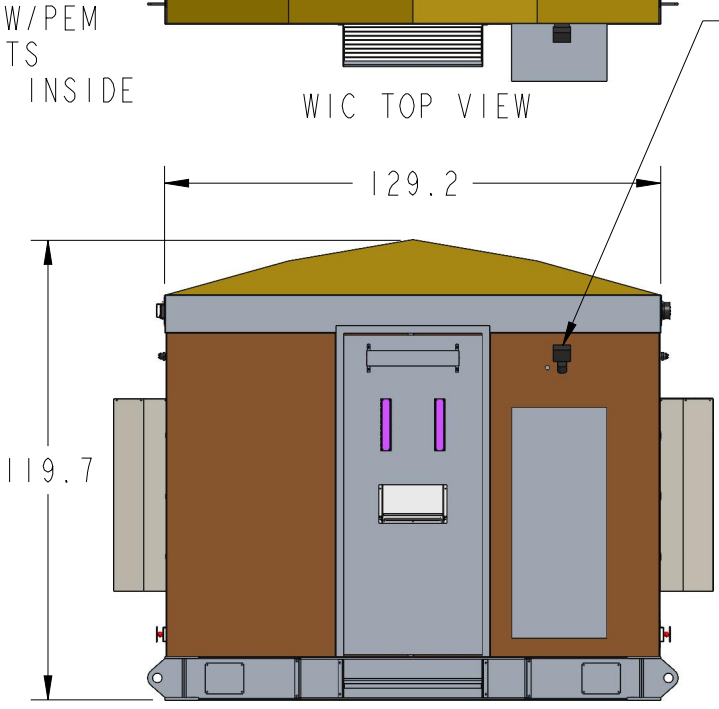

WIC FRONT VIEW

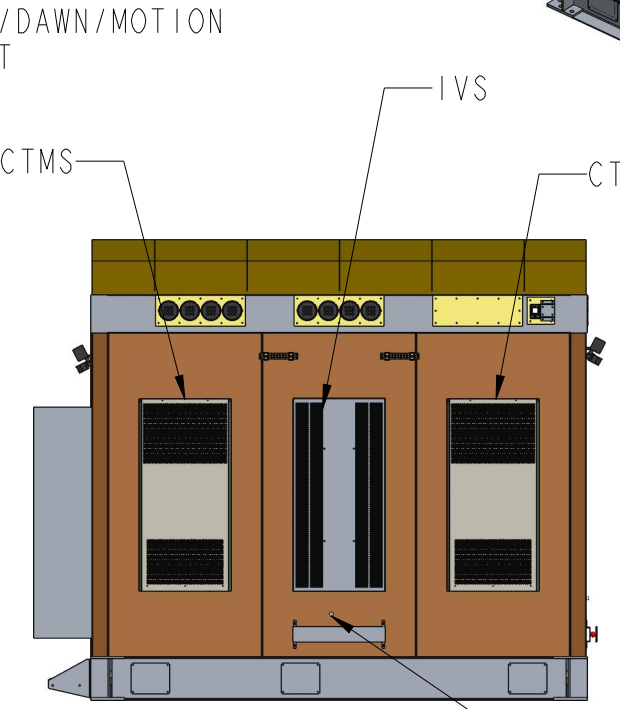

WIC RIGHT SIDE VIEW

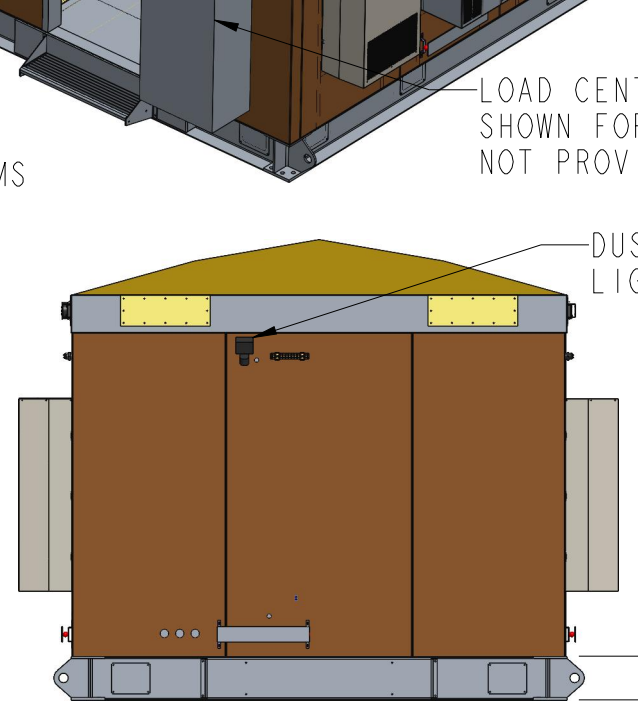

TRANSPORT HOLE FOR EXTERNAL GROUND CONNECTION TO MAIN GROUND BAR

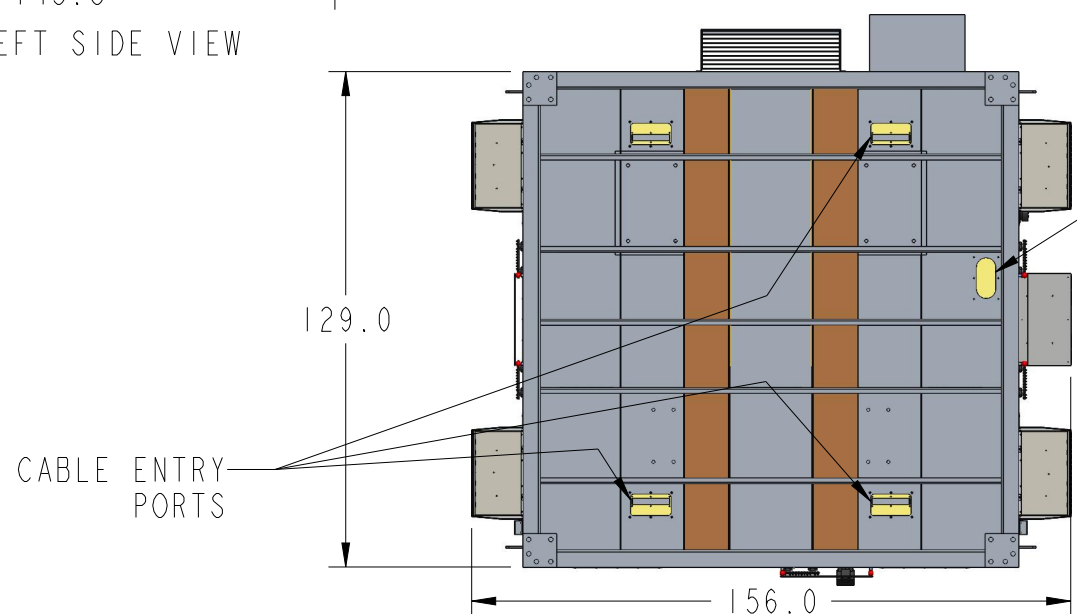

WIC BOTTOM VIEW

COVER PLATE FOR DC GENERATOR INLET

ESTIMATED WEIGHT WITHOUT EQUIPMENT/RACKS: 7,850 LBS  
 ESTIMATED WEIGHT WITH EQUIPMENT/RACKS: 13,850 LBS

GROUND BARS:  
 12 POSITION UNDER EXTERIOR ENTRY PANELS  
 24 POSITION ON EXTERIOR BOTTOM  
 46 POSITION MAIN GROUND BAR IN INTERIOR REAR WALL

	SIZE	DRAWING NO.	ISS.
	<b>B</b>	10X10 WIC W/STEPS	REV.
<small>THIS IS THE PROPERTY OF CHARLES INDUSTRIES LTD. AND SHALL NOT BE REPRODUCED, COPIED OR USED IN ANY MANNER DETRIMENTAL TO THEIR INTERESTS.</small>		SCALE .020	SHEET 1 of 4

4

3

2

1

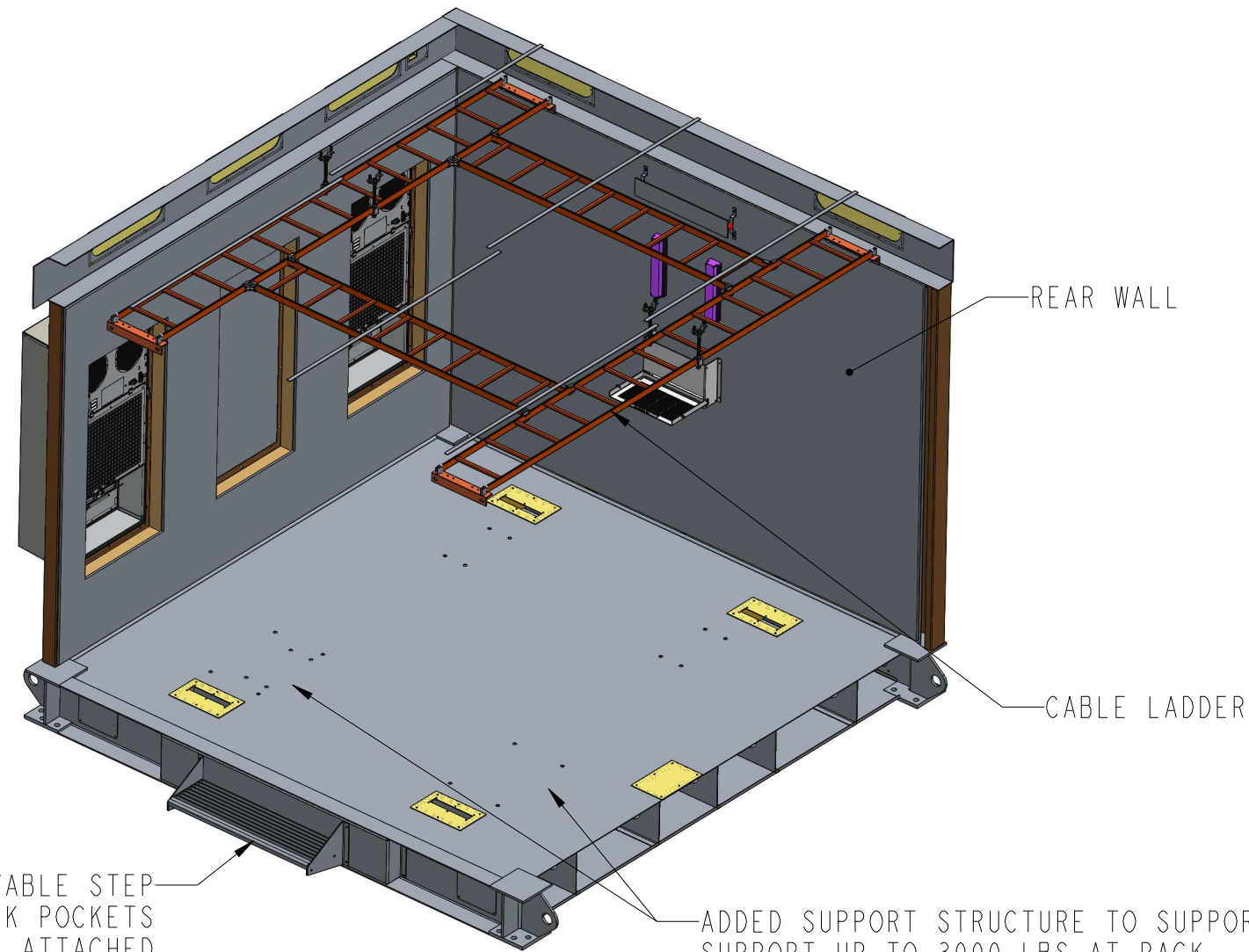
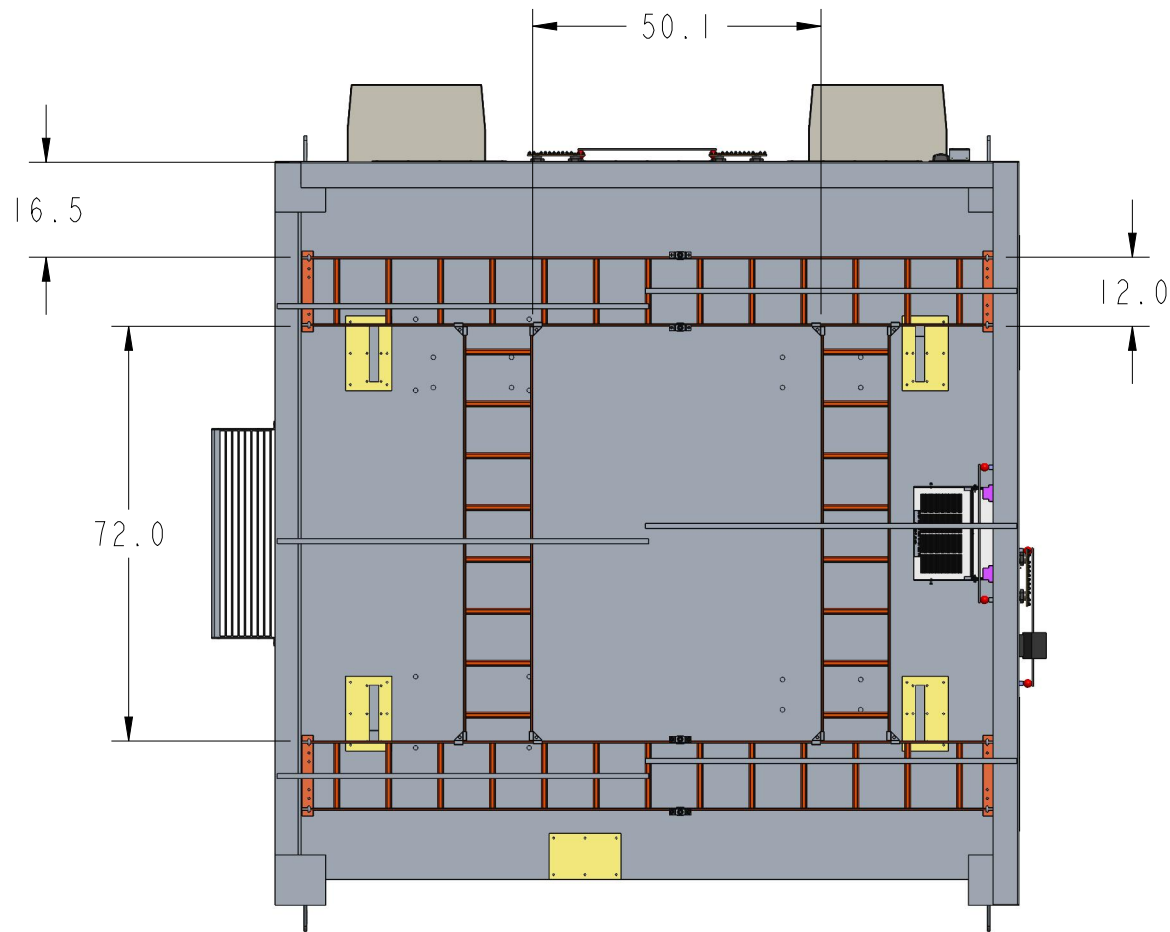

REAR WALL

CABLE LADDER

OPTIONAL REMOVABLE STEP  
 ALLOWS ACCESS TO FORK POCKETS  
 DOES NOT SHIP WITH ATTACHED  
 FROM CHARLES

ADDED SUPPORT STRUCTURE TO SUPPORT  
 SUPPORT UP TO 3000 LBS AT RACK  
 LOCATIONS BY DOOR

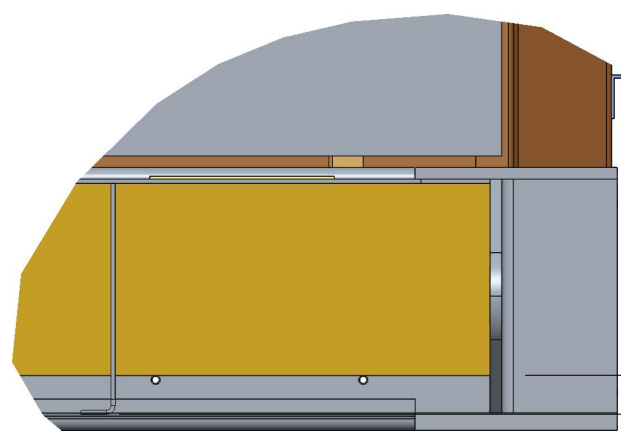

1.7 SPACE BETWEEN  
 SUPPORT AND BOTTOM PANELS  
 TO ROUTE CABLES SIDE TO SIDE

DETAIL A  
 SCALE .120

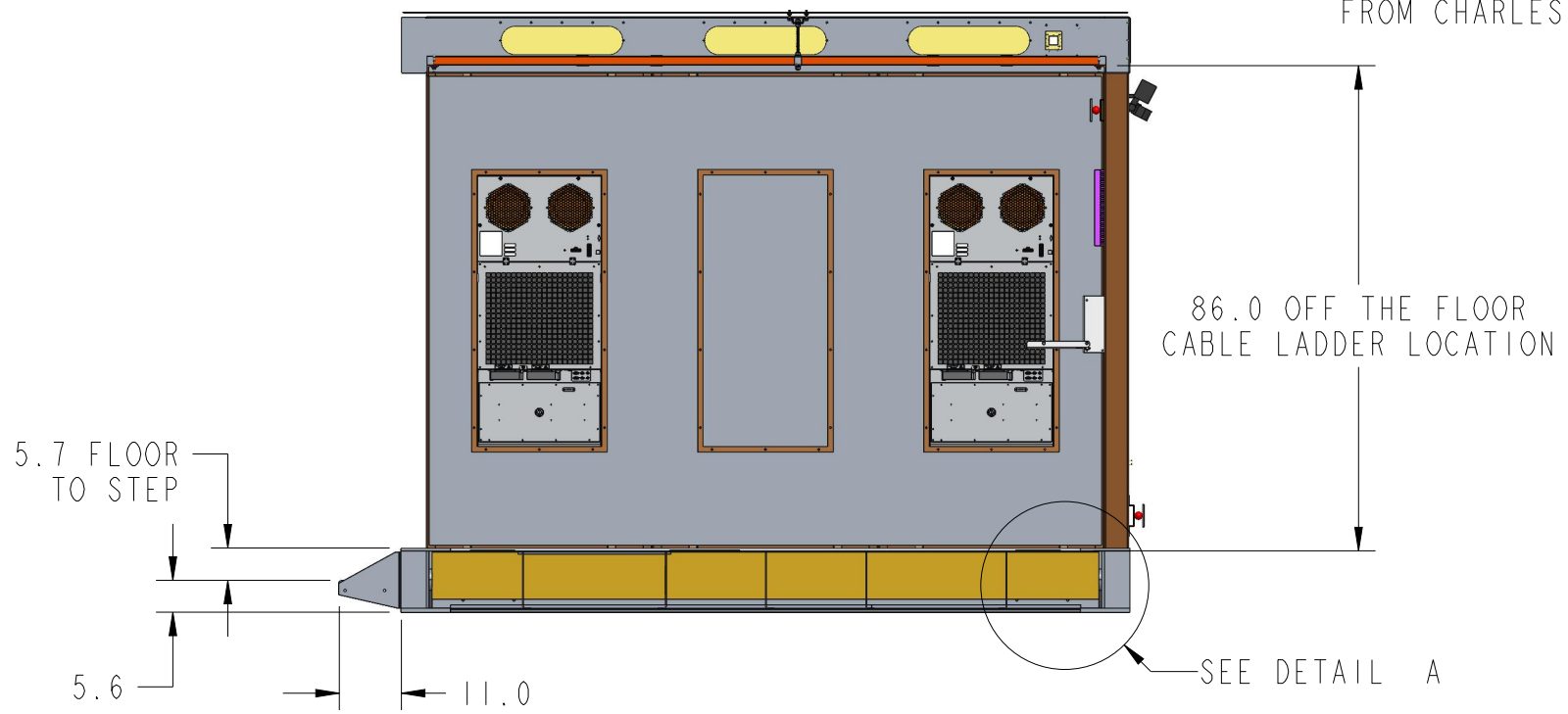

86.0 OFF THE FLOOR  
 CABLE LADDER LOCATION

SEE DETAIL A

	SIZE	DRAWING NO.	ISS.
	B	10X10 WIC W/STEPS	REV.
<small>THIS IS THE PROPERTY OF CHARLES INDUSTRIES LTD. AND SHALL NOT BE REPRODUCED, COPIED OR USED IN ANY MANNER DETRIMENTAL TO THEIR INTERESTS.</small>		SCALE .030	CAD FILE NAME WIC
		SHEET	2 of 4

4

3

2

1

D

D

C

C

B

B

A

A

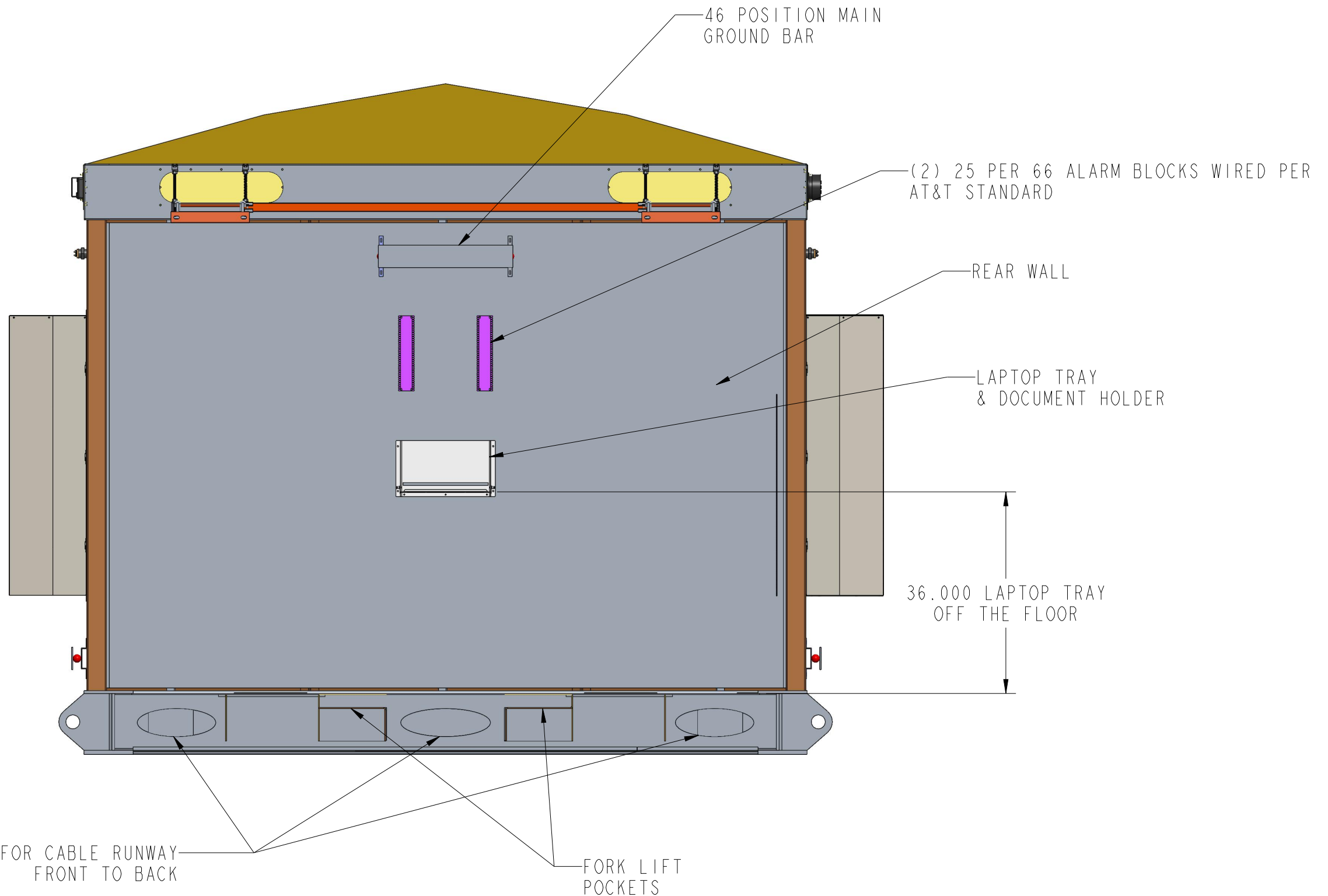

 <p>Charles Industries, Ltd. www.charlesindustries.com</p>	SIZE	DRAWING NO.	ISS.
	<b>B</b>	10X10 WIC W/STEPS	REV.
<small>THIS IS THE PROPERTY OF CHARLES INDUSTRIES LTD. AND SHALL NOT BE REPRODUCED, COPIED OR USED IN ANY MANNER DETRIMENTAL TO THEIR INTERESTS.</small>		SCALE .050	CAD FILE NAME WIC
		SHEET	3 of 4

3

2 DO NOT SCALE DRAWING

1

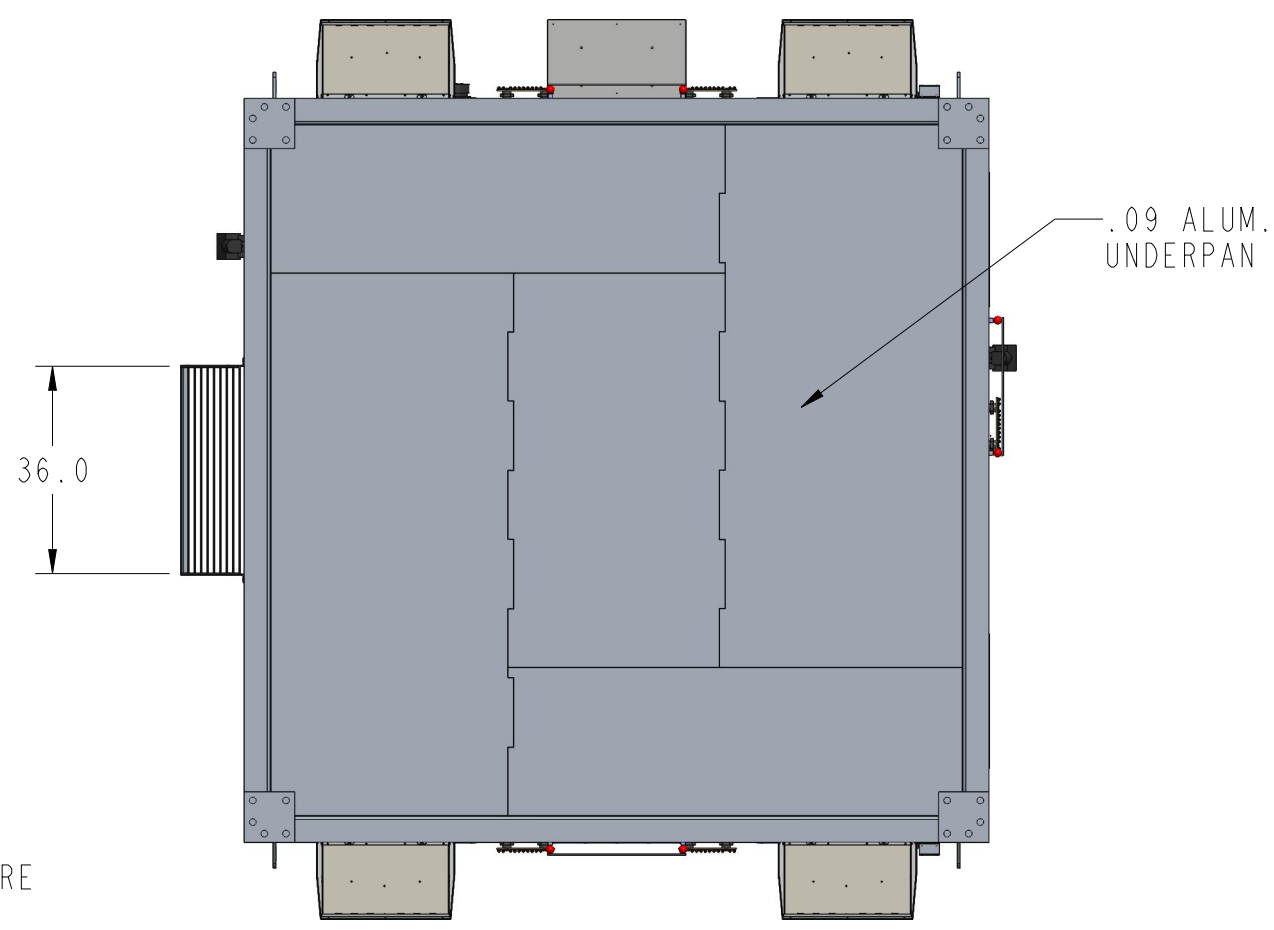
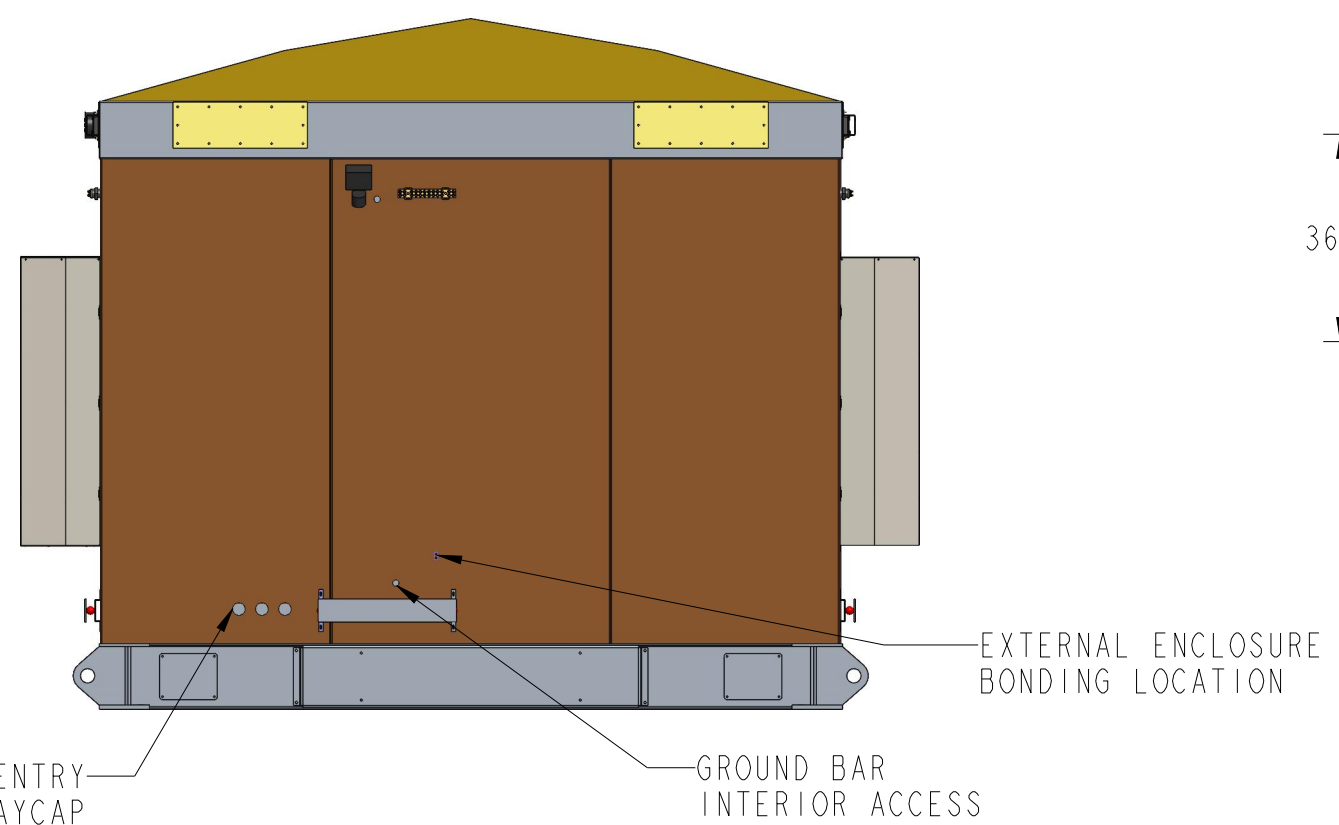
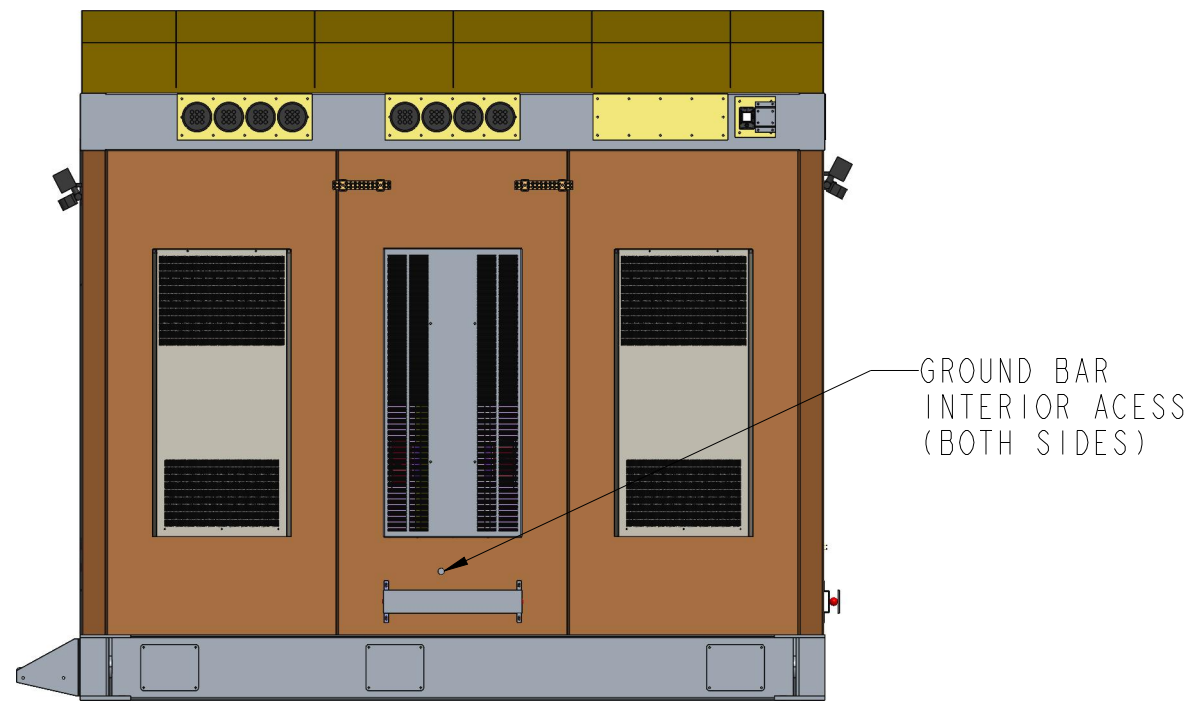
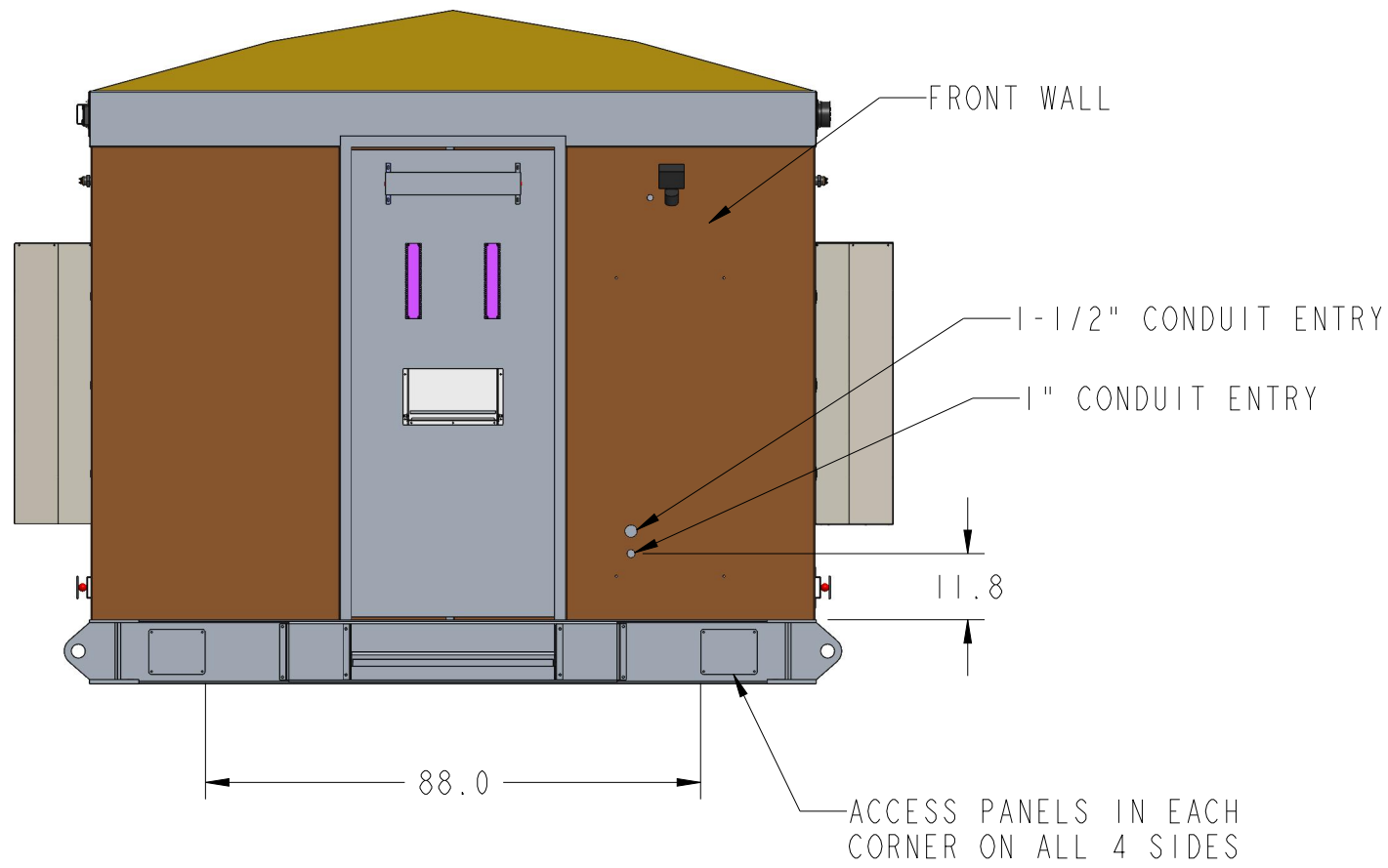

 <small>Charles Industries, Ltd. www.charlesindustries.com</small>	SIZE	DRAWING NO.	ISS.
	<b>B</b>	10X10 WIC W/STEPS	REV.
<small>THIS IS THE PROPERTY OF CHARLES INDUSTRIES LTD. AND SHALL NOT BE REPRODUCED, COPIED OR USED IN ANY MANNER DETRIMENTAL TO THEIR INTERESTS.</small>		SCALE	CAD FILE NAME
		.030	WIC
		SHEET	4 of 4